

ACCESORIOS PARA VÁLVULAS CON ACTUADOR SERIE RV-FLUID

SWITCH BOX CON MICROINTERRUPTORES ELECTROMECÁNICOS PARA ACTUADOR

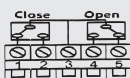

Voltaje: max 125/250V AC
 Intensidad: min 30mA
 max 2.5A
 Temperatura: -25°C a +125°C
 Protección: IP67

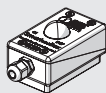

Código	Descripción	Peso [g]
W0900300915	Caja de interruptores con microinterruptores electromecánicos para actuador tamaño 32	196

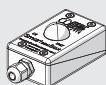

W0900300916	Caja de interruptores con microinterruptores electromecánicos para actuador tamaño 42 - 63	152
-------------	--	-----

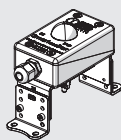

W0900300917	Caja de interruptores con microinterruptores electromecánicos para actuador tamaño 115 - 145	384
-------------	--	-----

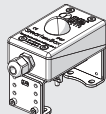

W0900300919	Caja de interruptores con microinterruptores electromecánicos para actuador tamaño 75 - 100	384
-------------	---	-----

Nota: a richiesta sono disponibili switch box con sensori induttivi e certificazione ATEX

INDICADOR DE POSICIÓN PARA ACTUADOR



Código	Descripción	Peso [g]
W0900300930	Indicador de posición para actuador tamaño 32 - 63	16



W0900300931	Indicador de posición para actuador tamaño 75 - 100	22
-------------	---	----



W0900300933	Indicador de posición para actuador tamaño 32 - 100 (sin caja de interruptores)	52
-------------	---	----



W0900300932	Indicador de posición para actuador tamaño 115 - 145	26
-------------	--	----

VÁLVULAS DE CONTROL CON INTERFAZ NAMUR

Véase página B1.47

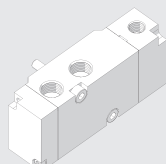

KIT ADATTATORE QUADRO

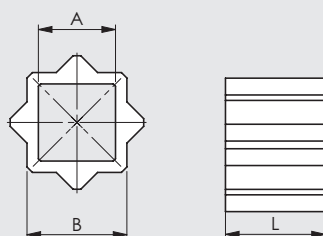

Codice	Descrizione	A	B	L	Peso [g]
W0900301001	Kit adattatore quadro RV-FLUID 08/11	8	11	12	7
W0900301002	Kit adattatore quadro RV-FLUID 09/11	9	11	12	6
W0900301006	Kit adattatore quadro RV-FLUID 09/13	9	13	12	11
W0900301007	Kit adattatore quadro RV-FLUID 11/13	11	13	12	7
W0900301008	Kit adattatore quadro RV-FLUID 11/14	11	14	16	13
W0900301003	Kit adattatore quadro RV-FLUID 14/17	14	17	17	19
W0900301005	Kit adattatore quadro RV-FLUID 14/22	14	22	22	65
W0900301009	Kit adattatore quadro RV-FLUID 16/22	16	22	22	52
W0900301004	Kit adattatore quadro RV-FLUID 17/22	17	22	22	48

Nota: adattatori a norma ISO 5211 - DIN 3337 acciaio inossidabile sinterizzato protezione alcalina statica bianca

KIT MOLLE PER VERSIONE SEMPLICE EFFETTO

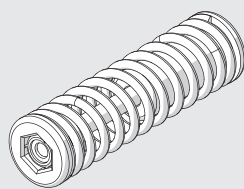

Codice	Ø	Quantità per kit
W0900303002	42	8
W0900303003	50	12
W0900303004	63	12
W0900303005	75	12
W0900303006	85	12
W0900303007	100	12
W0900303008	115	12
W0900303009	125	12
W0900303010	145	12

Nota: le molle sono fornite precomprese con apposito supporto al fine di agevolare l'installazione: **non rimuovere la molla dal proprio supporto per alcun motivo.**

RECAMBIOS PARA VÁLVULAS CON ACTUADOR SERIE RV-FLUID

KIT DI GUARNIZIONI ED ELEMENTI DI SCORRIMENTO

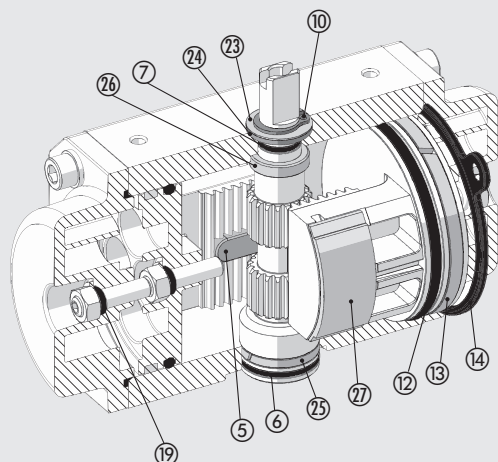

Codice	Ø	Particolari
W0900302001	32	6-7-10-12-13-14-19-23-24-25-26-27
W0900302002	42	5-6-7-10-12-13-14-19-23-24-25-26-27
W0900302003	50	5-6-7-10-12-13-14-19-23-24-25-26-27
W0900302004	63	5-6-7-10-12-13-14-19-23-24-25-26-27
W0900302005	75	5-6-7-10-12-13-14-19-23-24-25-26-27
W0900302006	85	5-6-7-10-12-13-14-19-23-24-25-26-27
W0900302007	100	5-6-7-10-12-13-14-19-23-24-25-26-27
W0900302008	115	5-6-7-10-12-13-14-19-23-24-25-26-27
W0900302009	125	5-6-7-10-12-13-14-19-23-24-25-26-27
W0900302010	145	5-6-7-10-12-13-14-19-23-24-25-26-27